



EXS 2010

# OWNER'S MANUAL

Digital Spread  
Spectrum Provides  
Long Range,  
Clear Sound  
and Secure  
Communication.

Uniden®

# INTRODUCTION

TO YOUR NEW PHONE

## Introduction

Thank you for choosing the Uniden EXS 2010 cordless telephone. This phone is designed for reliability, long life, and outstanding performance utilizing the latest in 900 MHz Digital Spread Spectrum technology.

**Note:** Some illustrations in this manual may differ from the actual unit for explanation purposes.

## Features

- 900 MHz Digital Spread Spectrum Technology
- 10 Memory Dial Locations
- 32 Digit Redial
- Flash and Pause
- Pulse / Tone Dialing
- Page
- 6 Hour Talk Time
- 10 Day Standby Time
- Handset Earpiece and Ringer Volume Controls
- Hearing Aid Compatible
- Lighted Keypad
- Headset Compatible

**Digital Spread Spectrum Technology** utilizes a “wider frequency band” vs. a “single narrow band” used in standard digital transmissions. The result is a more secure conversation with the clarity of digital sound, extended range, and minimal interference from other cordless phone.

**Random Code™** digital security automatically selects one of over 65,000 codes for the handset and base.

These features enhance your phone's security and also prevent unauthorized calls as a result of your phone being activated by other equipment.

The EXS 2010 features include **AutoTalk™** and **AutoStandby™**. AutoTalk allows you to answer a call by just removing the handset from the base so you don't have to waste time pushing buttons or flipping switches. AutoStandby allows you hang up by simply returning the handset to the base.

## Controls and functions

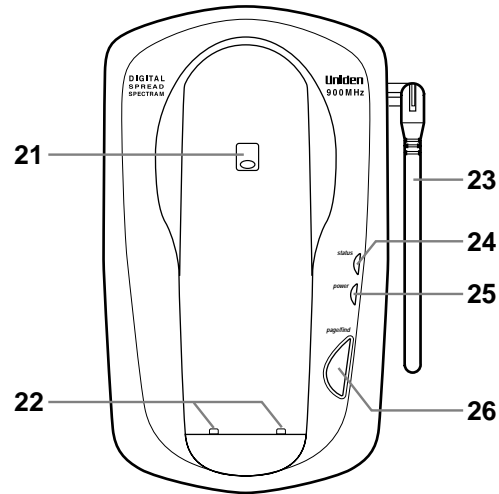
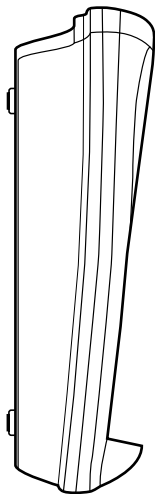
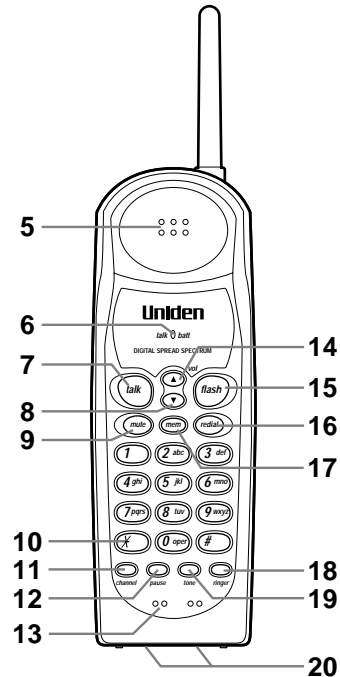
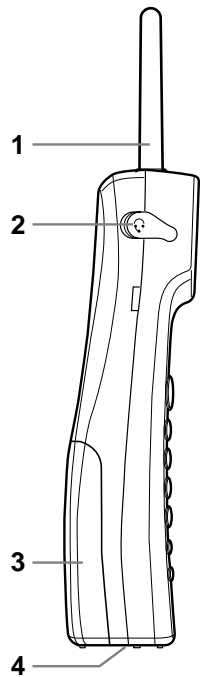

- 1. Handset antenna
- 2. Headset jack cover
- 3. Handset battery compartment
- 4. Handset ring switch
- 5. Handset speaker
- 6. Talk/Batt LED
- 7. Talk key
- 8. Volume down key
- 9. Mute key
- 10. ✕ key
- 11. Channel key
- 12. Pause key
- 13. Handset microphone
- 14. Volume up key
- 15. Flash key
- 16. Redial key
- 17. Memory key
- 18. Ringer key
- 19. Tone key
- 20. Handset battery charging contacts
- 21. Handset retainer clip
- 22. Base charging contacts
- 23. Base antenna
- 24. Status LED
- 25. Power LED
- 26. Page/Find key
- 27. Pulse-Tone switch
- 28. DC power input
- 29. Phone jack

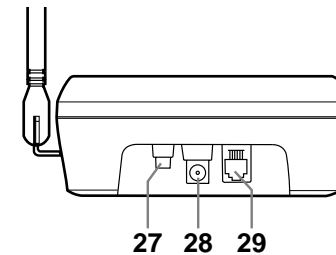
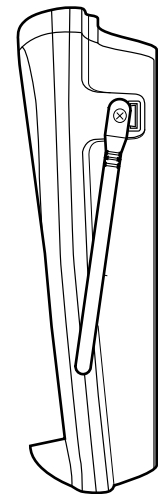

## Contents

Introduction / Features.....inside front cover  
Controls and Functions .....inside front cover

### Getting Started

Read this first.....2  
Step 1: Checking the package contents.....3  
Step 2: Setting up the base unit .....4  
    Mounting the base unit on a wall .....7  
Step 3: Installing the handset battery pack.....9  
    Automatic digital code security.....10

### Basics

Making a call .....11  
Receiving a call .....12  
Ringer mute .....12  
Flash and Call Waiting .....13  
Adjusting the ringer and earpiece volume .....13  
Redialing a call .....14  
Mute .....15  
Using page feature .....16

### Memory Dialing

Storing phone numbers .....17  
Making calls with memory dialing.....18  
Chain dialing.....18  
Erasing a stored phone number.....19

### Additional Information

Installing the beltclip.....20  
Headset installation .....20  
Note on power sources .....21  
Maintenance.....21

**Troubleshooting** .....22

**Index** .....24

Getting Started

Basics

Memory Dialing

Additional  
Information

**Read this first**

This cordless telephone must be set up before use. Follow these steps:

**Step 1** (page 3)

Unpack and check the telephone and accessories.

**Step 2** (page 4 to 8)

Next, choose the best location to set up the base unit.



**Base unit**

**Step 3** (page 9 to 10)

Then, insert the battery pack into the handset. You must charge the battery pack for 15 - 20 hours before using the phone.



**Handset**

**About the digital security code**

This cordless telephone uses a digital security code to prevent unauthorized access to your base unit. This security code prevents other cordless handsets from making calls through your base unit. A random security code will be assigned automatically between your base unit and handset when you charge the battery pack for the first time.

## Checking the package contents

Make sure you have received the following items in the package. If any of these items are missing or damaged, contact the **Uniden Parts Department** (see below).



• **Base unit**



• **Handset**

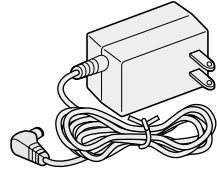

• **AC adapter (AD-310)**

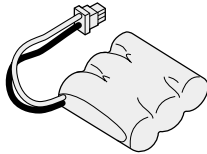

• **Rechargeable battery pack (BT-905)**

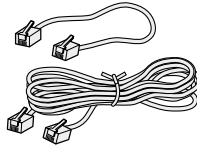

• **Telephone line cord (2)**

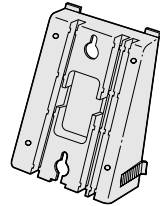

• **Wall mount adapter**

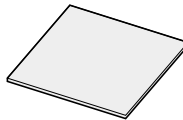

• **Memo sticker**

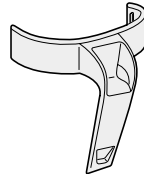

• **Beltclip**

- **This Owner's Manual**
- **Precautions and Important Safety Instructions**
- **Registration Card**
- **Quick Reference Guide**

### Uniden Parts Department

(800) 554-3988

Hours: M-F 8:30 AM to 5:00 PM CST.

We can also be reached on the web at [www.uniden.com](http://www.uniden.com).

## Setting up the base unit

Do the following steps.

- Choose the best location
- Connect the base unit
- Choose the dialing mode

### Choose the best location

Before choosing a location for your new phone, read the INSTALLATION CONSIDERATIONS included in the PRECAUTIONS AND IMPORTANT SAFETY INSTRUCTIONS brochure. Here are some important guidelines you should consider:

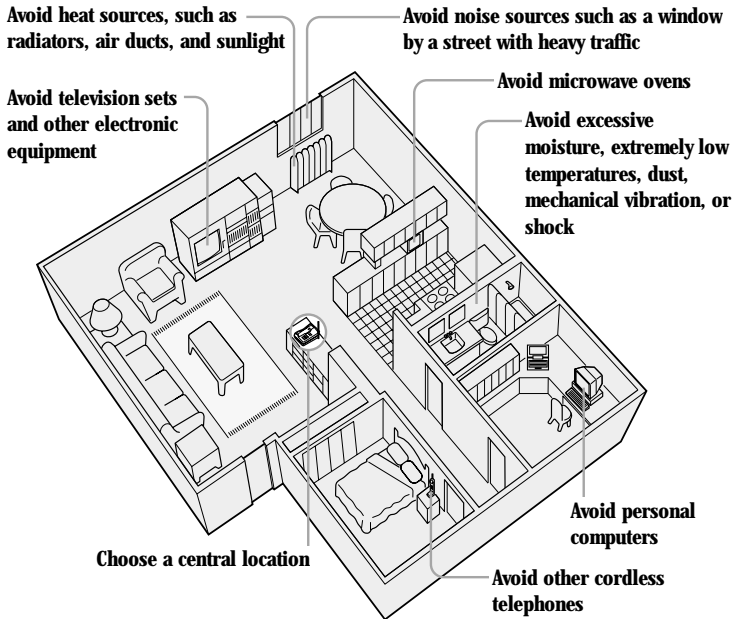

- You should charge your handset for 15 - 20 hours before using the phone.
- The location should be close to both a phone jack and continuous power outlet which is not switchable.
- Keep the base and handset away from sources of electrical noise such as motors and fluorescent lighting.
- Be sure there is sufficient space to raise the base antenna fully vertical.
- The base can be placed on a desk, tabletop or mounted on a standard wall plate.

## Connect the base unit

If you want to install the base unit on the wall, see page 7.

### NOTE

Place the power cord so it does not create a trip hazard, or where it could become chafed and create a fire or electrical hazard.

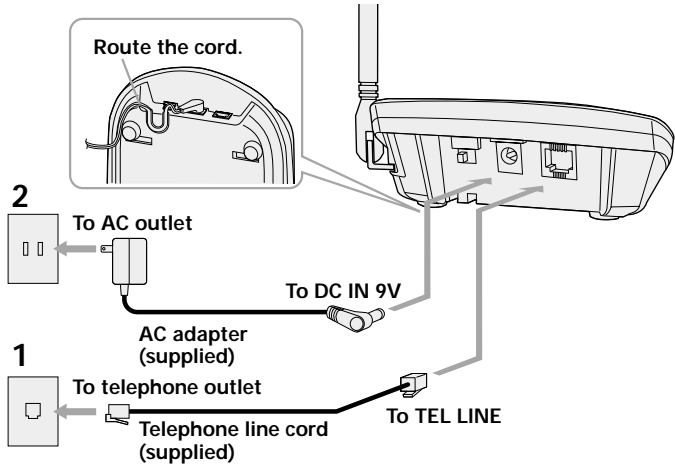

- 1** Connect the telephone line cord to the **TEL LINE** jack and to a telephone outlet.
- 2** Connect the AC adapter to the **DC IN 9V** jack and to a standard 120V AC wall outlet.
- 3** Set the base unit on a desk or tabletop and place the handset on the base unit. Then raise the antenna to a vertical position.

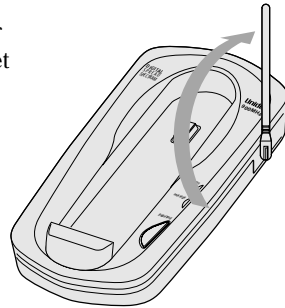



Use only the supplied AD-310 AC adapter. Do not use any other AC adapter.

**Polarity of the plug**

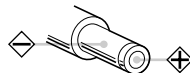

Connect the AC adapter to a continuous power supply.



Place the base unit close to the AC outlet so that you can unplug the AC adapter easily.



If your telephone outlet isn't modular, contact your telephone company for assistance.

**Modular**



## Choose the dialing mode

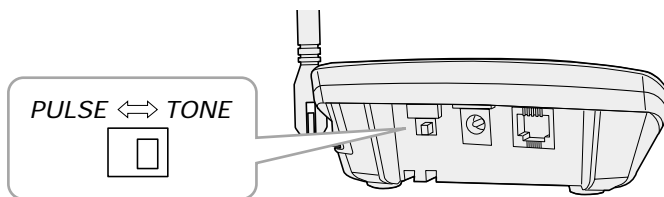

Depending on your dialing system, set the **PULSE-TONE** switch as follows:

<b>If your dialing system is</b>	<b>Set the switch to</b>
Tone	<b><i>TONE</i></b>
Pulse	<b><i>PULSE</i></b>

### **If you aren't sure of your dialing system**

Make a trial call with the **PULSE-TONE** switch set to ***TONE***.

If the call connects, leave the switch as is; otherwise, set to ***PULSE***.



## Mounting the base unit on a wall

### Standard wall plate mounting

This phone can be mounted on any standard telephone wall plate.

1

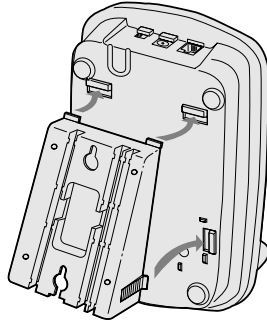

1 Snap the wall mount adapter into the notches on the base.

2 Plug the telephone line cord to the **TEL LINE** jack and the AC adapter to the **DC IN 9V** jack.

3 Plug the telephone line cord into the telephone outlet.

4 Wrap the AC adapter cord inside the molded wiring channel. Then wrap the cord around the strain relief notch.

5 Plug the AC adapter into a standard 120V AC wall outlet.

6 Raise the antenna to a vertical position.

7 Align the mounting slots on the base with the mounting posts on the wall. Push in and down until the phone is firmly seated.

2 - 7

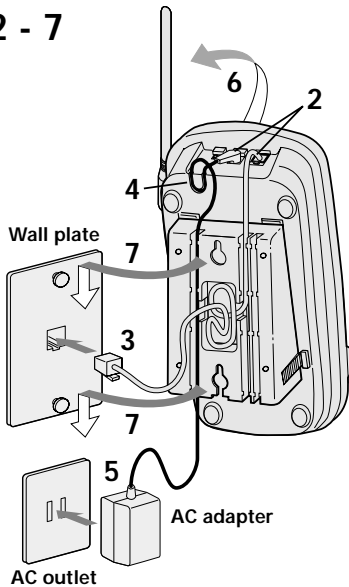



If the handset beltclip is attached, you cannot charge the handset facing forward when the phone is mounted on the wall (See page 20).

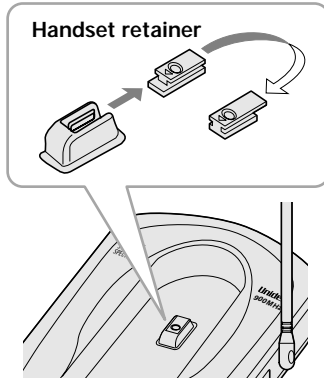

- 8** On the base unit, pull the handset retainer out of the slot. Rotate it clockwise 180 degrees.
- 9** Flip the retainer from front to back. Slide it back into the slot so that the lip of the retainer is up and the oval is down. The retainer holds the handset in place.

## Direct wall plate mounting

If you don't have a standard wall plate, you can mount your phone directly to the wall. Before doing this, consider the following:

- Avoid electrical cables, pipes, or other items behind the mounting location, that could cause a hazard when inserting screws into the wall.
- Try to mount your phone within 10 - 15 feet of a working phone jack to avoid excessive cord lengths.
- Make sure the wall material is capable of supporting the weight of the base and handset.
- Use #10 screws (minimum length of 1-3/8 inches) with anchoring devices suitable for the wall material where the base unit will be placed.

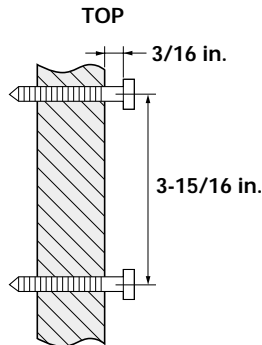

- 1** Insert two mounting screws into the wall, (with their appropriate anchoring device), 3-15/16 inches apart. Allow about 3/16 of an inch between the wall and screwheads for mounting the phone.
- 2** Refer to steps 1 through 9 on page 7 and 8 to mount the telephone.

## Installing the handset battery pack

Charge the battery pack for 15 - 20 hours before you start using your phone.

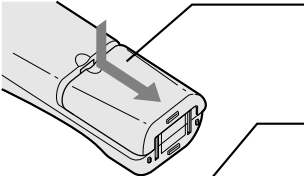
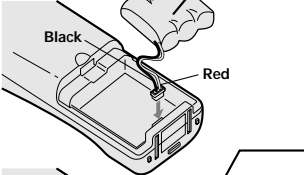
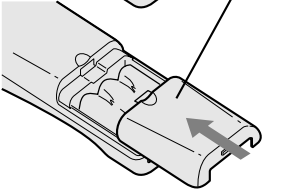
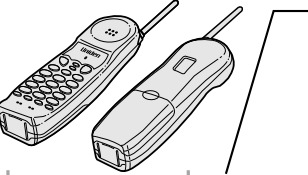
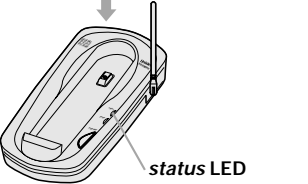
-  1 Press the battery cover release.
-  2 Connect the battery pack connector with the correct polarity (black and red wires), then insert the battery pack into the battery compartment.
-  3 Slide the battery cover forward until it snaps into place.
-  4 Place the handset on the base.
-  5 Make sure that the **status** LED lights. If the LED doesn't light, check to see that the AC adapter is plugged in and that the handset makes good contact with the base charging contacts.



Use only Uniden Battery (BT-905) supplied with your phone.

## NOTE

Even when the battery pack is not being used, it will gradually discharge over a long period. For optimum performance, be sure to return the handset to the base unit after a telephone call for charging the battery.

## Battery use time (per charge)

From fully charged

- Six hours continuous use.
- Ten days when the handset is in the standby mode.

## When the battery charge becomes low

When the voltage of battery pack in the handset is very low and needs to be charged, the phone is programmed to eliminate functions in order to save power. If the battery charge becomes low, *talk/batt* LED blinks. If the phone is in use, the handset beeps. Complete your conversation as quickly as possible and return the handset to the base unit for charging.

## Cleaning the charging contacts

To maintain a good charge, it is important to clean the charging contacts on the handset and base unit about once a month. Use a pencil eraser to gently wipe the handset and base charging contacts.

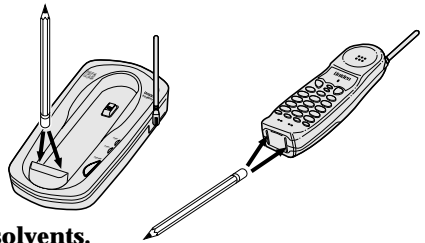

**Do not use any liquids or solvents.**

## Automatic digital code security

To prevent other parties from making unauthorized calls on your phone line, a digital code was added to the EXS 2010. Your phone's handset and base share this code, which is randomly set each time you place the handset on the base.

## Making a call

### NOTE

If the *talk/batt* LED does not stop flashing after pressing the *(talk)* key, place the handset on the base for at least five seconds and make a call again.

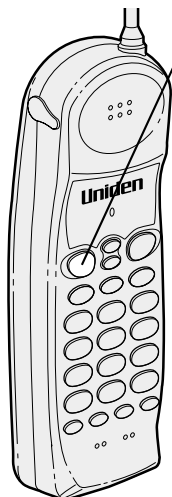

- 1 Press *(talk)* . Listen for dial tone.
- 2 Dial the phone number.
- 3 To hang up, press *(talk)* or return the handset to the base.

## Other Operations

To	Do this
To adjust the ear speaker volume	Press <i>(▲)</i> or <i>(▼)</i> during the call.
To temporarily switch to tone dial (When the base is set to pulse mode)	Press <i>(tone)</i> . The following numbers will be sent as tone dialing.
To improve reception	Press <i>(channel)</i> .

## NOTE

When you receive a call during a page or memory dialing operation, press **(talk)** to answer the call.

## Receiving a call

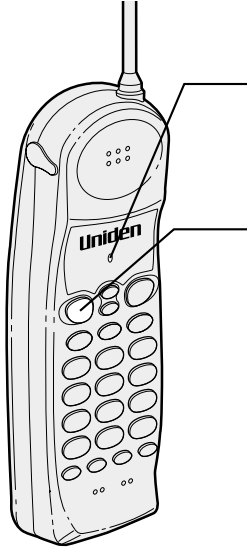

### Handset on the base

- 1 Phone rings. The **talk/batt** LED blinks.
- 2 Pick up the handset and begin speaking.
- 3 To hang up, press **(talk)** or return the handset to the base.

### Handset off the base

- 1 Phone rings. The **talk/batt** LED blinks.
- 2 Press **(talk)** or any key (except **(mute)**) and begin speaking.
- 3 To hang up, press **(talk)** or return the handset to the base.

## Ringer mute

You can temporarily mute the ringer by pressing **(mute)** when the phone rings.

You may still press **(talk)** to answer the call.

## Flash and Call Waiting

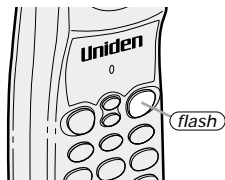

If you have "Call Waiting" service and a call waiting tone sounds while you are on a call, press **flash** to accept the waiting call. There is a short pause, then you will hear the new caller. To return to the original caller, press **flash** again.

## Adjusting the ringer and earpiece volume

### Ringer tone/volume

The phone has four types of ringer tone and volume combinations.

In standby mode, press **ringer** repeatedly on the handset.

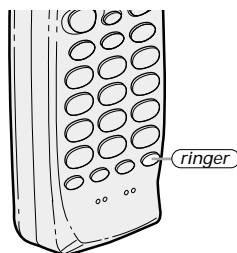

To turn the ringer off, set the **ringer on/off** switch to **off**.

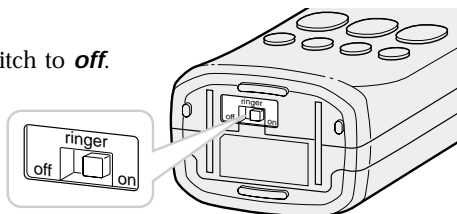

### Handset earpiece volume

The phone has four earpiece volume levels, Normal, Medium, High, and Loud. Pressing **▲** or **▼** will change the earpiece volume of the handset. This setting will remain in effect after the telephone call has ended.

When you press **▲** in Loud mode or press **▼** in Normal mode, error sound beeps.

## Redialing a call

The last phone number dialed can be quickly redialed.

### NOTE

If the recently dialed number exceeds 32 digits, only the first 32 digits can be redialed.



- 1 Press **(talk)**. The **talk/batt** LED lights.
- 2 Press **(redial)**.
- 3 To hang up, press **(talk)** or place the handset on the base.



## Mute

You can turn off the handset microphone and temporarily mute the ringer.

### When speaking on the handset

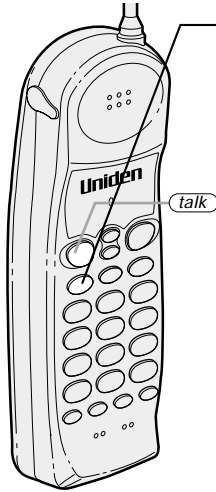

- 1 Press **(mute)** during a telephone call. The **talk/batt** LED flashes. The other party will not be able to hear you although you can hear them.
- 2 To cancel mute, press **(talk)** or **(mute)** again.

### When the phone is ringing

Press **(mute)** when the phone rings. The ringer sound turns off.

You may still press **(talk)** to answer the call.

## Using page feature

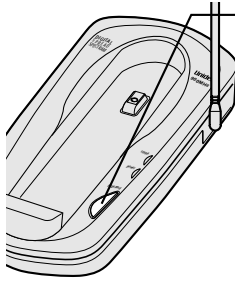

To locate the handset (while it's off the base), press **(page/find)** on the base. The handset beeps for 5 seconds.

### NOTE

If you cancel the page by pressing **(talk)**, press **(talk)** again to return to standby.

### NOTE

Press and hold **(page/find)** for more than 2 seconds to page the handset for a minute. Press any key or return the handset to the base to cancel the page.

If you hold down **(page/find)** for more than a minute, the handset beeps until you release **(page/find)**.

### Storing phone numbers

Your EXS 2010 stores up to 10 numbers in the handset.

#### NOTE

You must press a key within 20 seconds, or the phone will return to standby. If you return the handset in the cradle, the phone will also return to standby.

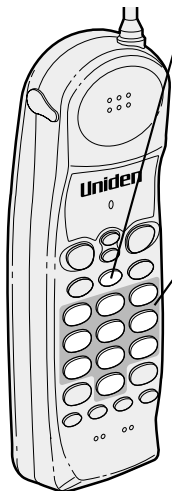

- 1 Press **mem** while in standby mode. The **talk/batt** LED flashes.
- 2 Dial the number you wish to store (up to 20 digits).
- 3 Press **mem** again.
- 4 Press a number key (0 - 9) to select the memory location where you wish to store the number.
- 5 The **talk/batt** LED goes out. A confirmation tone indicates the number has been stored.

#### NOTE

If a pause is needed during dialing to access long distance or other services, press **pause** to insert a 2-second pause between numbers. Entering a pause counts as one digit.

#### NOTE

Use the supplied memo sticker to write stored numbers.

## Making calls with memory dialing

### NOTE

If you select a memory location that does not have a stored number, the handset will beep rapidly. Press **(talk)** to return to standby.

### Memory dialing

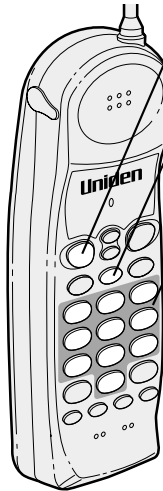

- 1 Press **(talk)**. The **talk/batt** LED lights.
- 2 Press **(mem)**.
- 3 Enter a number (0 - 9) to select the memory location you wish to dial.
- 4 To hang up, press **(talk)** or return the handset to the base.

### Chain dialing

On certain occasions after dialing a number, you may be requested to enter an access code or other information, such as your account number. You can enter this number into a memory location for later use by doing the following.



- 1 Store the access code into one of the memory location (0 - 9) following the steps on page 17.
- 2 Dial the party or service main number.
- 3 When you need to enter the special number, press **(mem)** followed by the memory location (0 - 9).

## Erasing a stored phone number

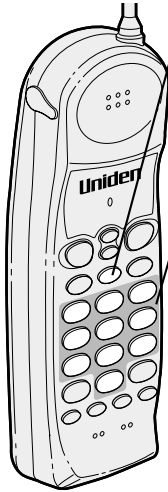

- 1** Press **mem** in the standby mode. The **talk/batt** LED flashes.
- 2** Press **mem** again.
- 3** Enter the memory location number (0 - 9) you wish to delete. A confirmation beep indicates the number has been erased.

## NOTE

If you have wall mounted the base, you must remove the beltclip to charge the handset facing forward.

## Installing the beltclip

### To attach the beltclip

Insert the beltclip into the holes on each side of the handset. Press down until it clicks.

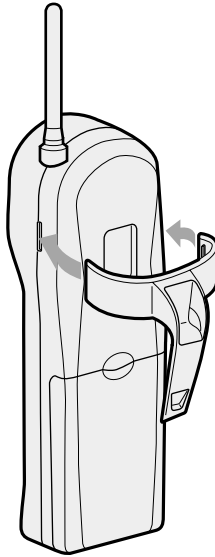

### To remove the beltclip

Pull both sides of the beltclip to release the tabs from the holes.

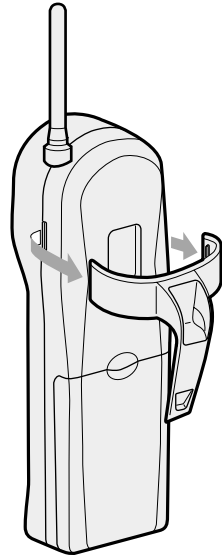

## Headset installation

Your phone may be used with an optional headset, the Uniden HS910. To use this feature, simply plug the headset plug into the headset jack. Your phone is ready for hands-free conversation.

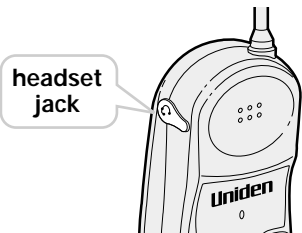

## Note on power sources

### Battery replacement and handling

When the operating time becomes short, even after a battery is recharged, please replace the battery.

With normal usage, your battery should last about one year.

Please contact your place of purchase for a replacement battery.

#### Power Failure

During the period that the power is off, you will not be able to make or receive calls with the telephone.

#### Caution

- Use the specified battery pack.
- Do not remove the battery from the handset to charge it.
- Never throw the battery into a fire, disassemble it, or heat it.
- Do not remove or damage the battery casing.

## Maintenance

#### When slightly dirty

Wipe with a soft, dry cloth.

#### When very dirty

Wipe with a soft cloth that has been dampened with diluted, neutral detergent. Dry with a dry cloth.

#### When the charging terminals become dirty

Wipe with a pencil eraser or other contact cleaner.

### RECYCLING NICKEL-CADMIUM BATTERIES



**NICKEL-CADMIUM BATTERIES MUST BE DISPOSED OF PROPERLY.**

Nickel-cadmium cells are used in the battery pack. Please take your used nickel-cadmium battery packs to a store that recycles nickel-cadmium batteries.

#### Caution

Do not use paint thinner, benzene, alcohol, or other chemical products. Doing so may discolor the surface of the telephone and damage the finish.

## Troubleshooting

If your phone is not performing to your expectations, please try these simple steps first.

Symptom	Suggestion
The <b>power</b> LED won't come on.	<ul style="list-style-type: none"> <li>• Make sure the AC adapter is plugged into the base unit and wall outlet.</li> </ul>
The <b>status</b> LED won't come on when the handset is placed in the base unit.	<ul style="list-style-type: none"> <li>• Make sure the handset is properly seated in the base unit.</li> <li>• Make sure the charging contacts on the handset and base unit are clean.</li> </ul>
The audio sounds weak and/or scratchy.	<ul style="list-style-type: none"> <li>• Make sure that the base unit antenna is in a vertical position.</li> <li>• Move the handset and or base unit to a different location away from metal objects or appliances and try again.</li> <li>• Make sure that you are not too far from the base.</li> </ul>
Can't make or receive calls.	<ul style="list-style-type: none"> <li>• Check both ends of the base unit telephone line cord.</li> <li>• Make sure the AC adapter is plugged into the base unit and wall outlet.</li> <li>• Disconnect the AC adapter for a few minutes, then reconnect it.</li> <li>• Make sure <b>(talk)</b> is pressed.</li> </ul>
The handset doesn't ring or receive a page.	<ul style="list-style-type: none"> <li>• The battery pack may be weak. Charge the battery on the base unit for 15 - 20 hours.</li> <li>• The handset may be too far away from the base unit.</li> <li>• Place the base unit away from appliances or metal objects.</li> <li>• Make sure Ringer switch of the handset is set to ON.</li> </ul>



**At Uniden, we'll take care of you!**

If you need any assistance with this product, please call our Customer Hotline at

**1-800-297-1023**

**PLEASE DO NOT RETURN THIS PRODUCT TO THE PLACE OF PURCHASE.**

Our Uniden representatives will be happy to help you with any matters regarding the operation of this unit, available accessories, or any other related matters.

Thank you for purchasing a Uniden product.  
Hours: M-F 7:00 AM to 7:00 PM CST.

## Index

### A, B

Battery pack	
Preparing and charging .....	9
Replacement and handling .....	21
Beltclip installation .....	20

### C

Chain dialing .....	18
Connection .....	5

### D

Dialing mode .....	6
Digital security code .....	2, 10

### E, F, G

Earpiece volume .....	13
-----------------------	----

### H, I, J, K, L

Handset ringer tone and volume .....	13
Headset installation .....	20

### M, N, O

Maintenance .....	21
Making a call .....	11
Memory dialing	
Erasing a stored phone number .....	19
Making calls with memory dialing .....	18
Storing phone numbers .....	17
Mounting the base unit to a wall .....	7
Mute .....	15

### P, Q

Package contents .....	3
Page feature .....	16

### R

Receiving a call .....	12
Redialing a call .....	14
Ringer mute .....	12

### S

Setup	
Base unit .....	4
Handset .....	9

### T, U, V, W, X, Y, Z

Troubleshooting .....	22
-----------------------	----



# THANK YOU

FOR PURCHASING A UNIDEN PHONE!

## Uniden®

Covered under one or more of the following U.S. patents:

4,511,761 4,523,058 4,595,795 4,797,916 5,381,460  
5,426,690 5,434,905 5,491,745 5,533,010 5,574,727  
5,650,790 5,660,269 5,661,780 5,663,981 5,671,248  
5,717,312 5,754,407 5,768,345 5,787,356 5,838,721

© 2000 Uniden America Corporation

All rights reserved • Printed in China UCZZ01668BZ